

BU29

CUSTOMER DWG.

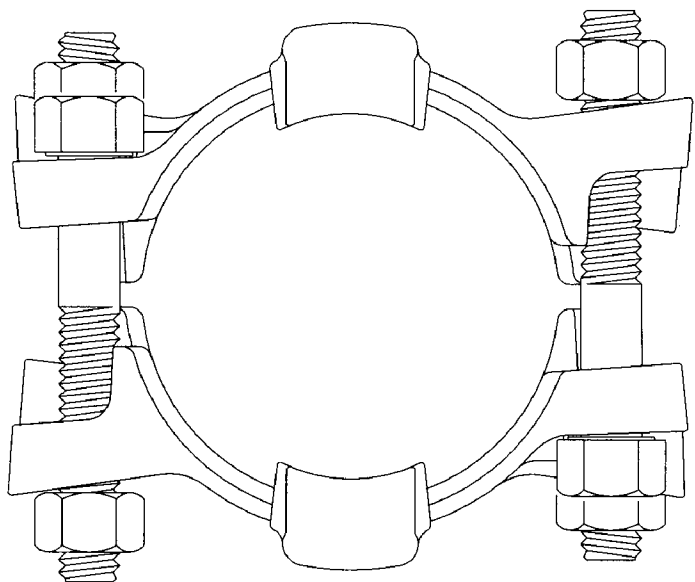

SECTION X-X

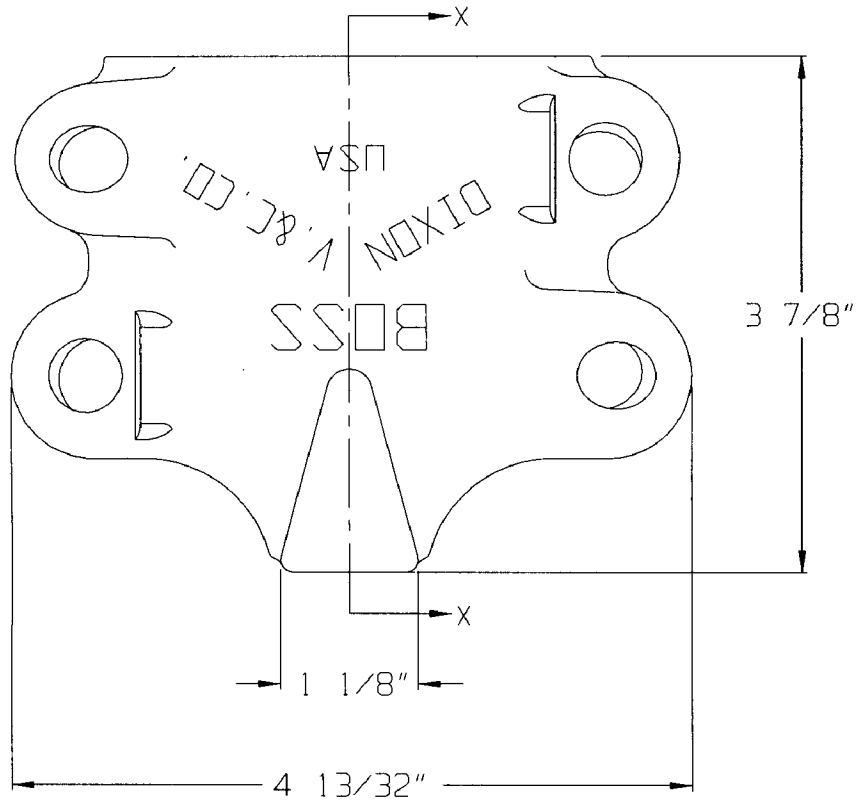
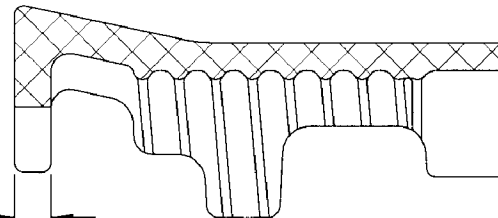

The Right Connection

HOSE O.D. RANGE
2 1/2" TO 2 25/32"

CUSTOMER DWG.

AGREEMENT TO MAINTAIN CONFIDENTIALITY

This drawing is owned by Dixon Valve & Coupling Co. and shall be returned upon demand. It is loaned on condition that it shall not be copied or reproduced or submitted to others without the owners consent. In accepting it subject to this condition the recipient further agrees that this drawing or any design detail or concept disclosed herein shall not be used in any way detrimental to or in competition with the Owner.

DIXON VALVE & COUPLING CO.
U. S. A.

TITLE
3" BOSS CLAMP
4-BOLT TYPE; 2 GRIPPING FINGERS

SCALE:
NOT TO SCALE

DRWN: TDJ
08/04/09

APPROVAL:
AK
8-6-09

MAT'L
DUCTILE IRON

BU29